

Service
Service
Service

Service Manual

ESBREL
RUA VITÓRIA N.º 301
FONE: 221-0688
SÃO PAULO - SP.

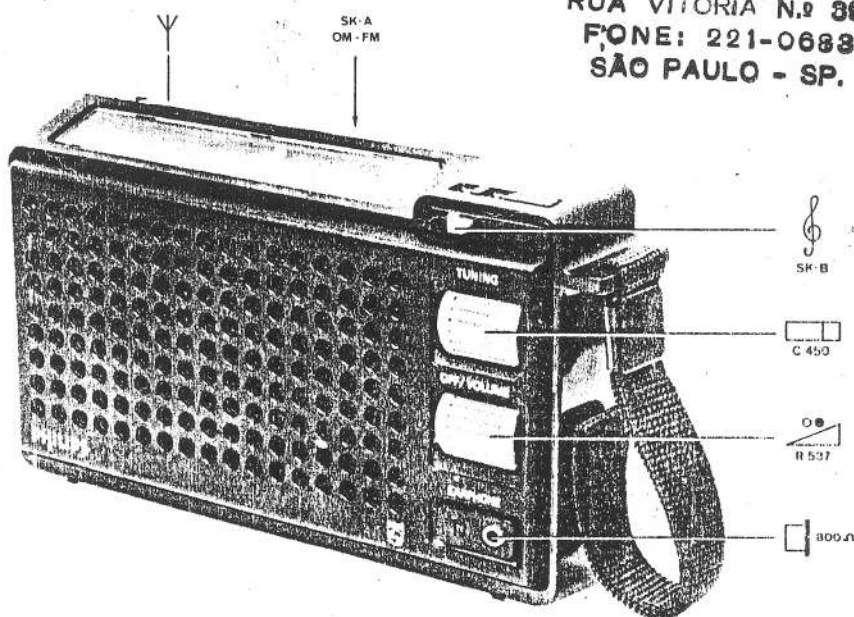

OM : 512 – 1610 kHz

FM : 86,5 – 109 MHz

—|— 6V (4xR6)

Potência: 700 mW (musical)

Consumo sem sinal: 13 a 20 mA

Dimensões: 178 x 106 x 47 mm

Documentation Technique Service Dokumentation Documentazione di Servizio Huolto-Ohje Manual de Servicio Manual de Serviço



















Subject to modification

4806 725 17035

Printed in Brazil

PHILIPS

SK					
OM	452 kHz		MÁX. CAP.	S 443 S 442 S 441	 MÁX.
FM	10,7 MHz		MÁX. CAP.	S 437 - S 436 S 435 - S 434	
				S 438	 MÍN.
OM	512 kHz		MÁX.	S 440	 MÁX.
	1610 kHz		MÍN.	C 450 h	
	580 kHz			S 439	
	1380 kHz			C 450 g	
FM	86,5 MHz		MÁX.	S 433	 MÁX.
	109 MHz		MÍN.	C 450 f	
	90 MHz			S 431	
	107 MHz			C 450 e	
REPETIR					

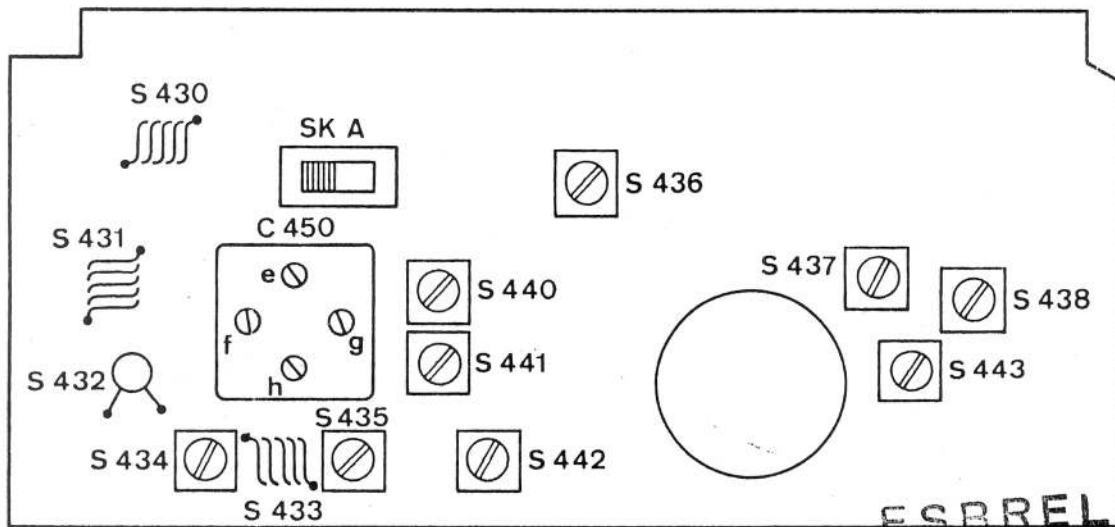
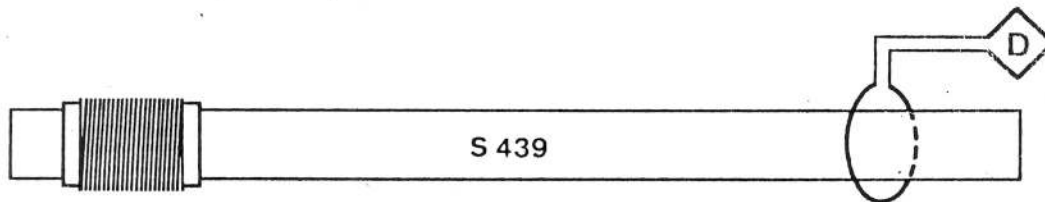

Ajuste da corrente do estágio de saída
(sem sinal de antena)

- Ligar um miliamperímetro em série com o coletor de TS 409, devendo indicar $3,5\text{mA} \pm 1,5\text{mA}$.
- Caso seja necessário reajustar, ligar em paralelo com R 543 um resistor de 12K, 15K ou 18K.

- TS -		- S -	
TS 401/402 TS 403	BF 494B	S 430 S 431 S 432 S 433 S 434/435 S 436 S 437 S 438 S 439 S 440 S 441 S 442 S 443 S 446	3106 308 20191 3106 308 20201 3106 108 22311 3106 308 20211 3106 308 20221 3106 308 20231 3106 308 20241 3106 308 20251 3106 308 20171 3106 108 22741 3106 308 20181 3106 108 22701 3106 108 22711 2406 264 01016
TS 404 TS 405	BF 495C BF 495D		
TS 406/407 TS 408	BC 548B		
TS 409 TS 410	BC 338 BC 328		
- D -		- C -	
D 413/416 D 418a/b. D 414/415 D 417 D 419/420	AA 119 CDGOO 8206 270 91731 1N4001	C 450 C 473/480 C 492 C 485/487 C 488 C 490/493 C 494	2020 801 00054 10 μ F 10V 2006 001 00144 1 μ F 40V 2006 001 00043 220 μ F 6,3V 2006 005 00006
- DIVERSOS -		- R -	
SKA SKB F.B. 444/445	3106 308 40071 3106 308 40081 4322 020 34401	R 537	2122 379 90001

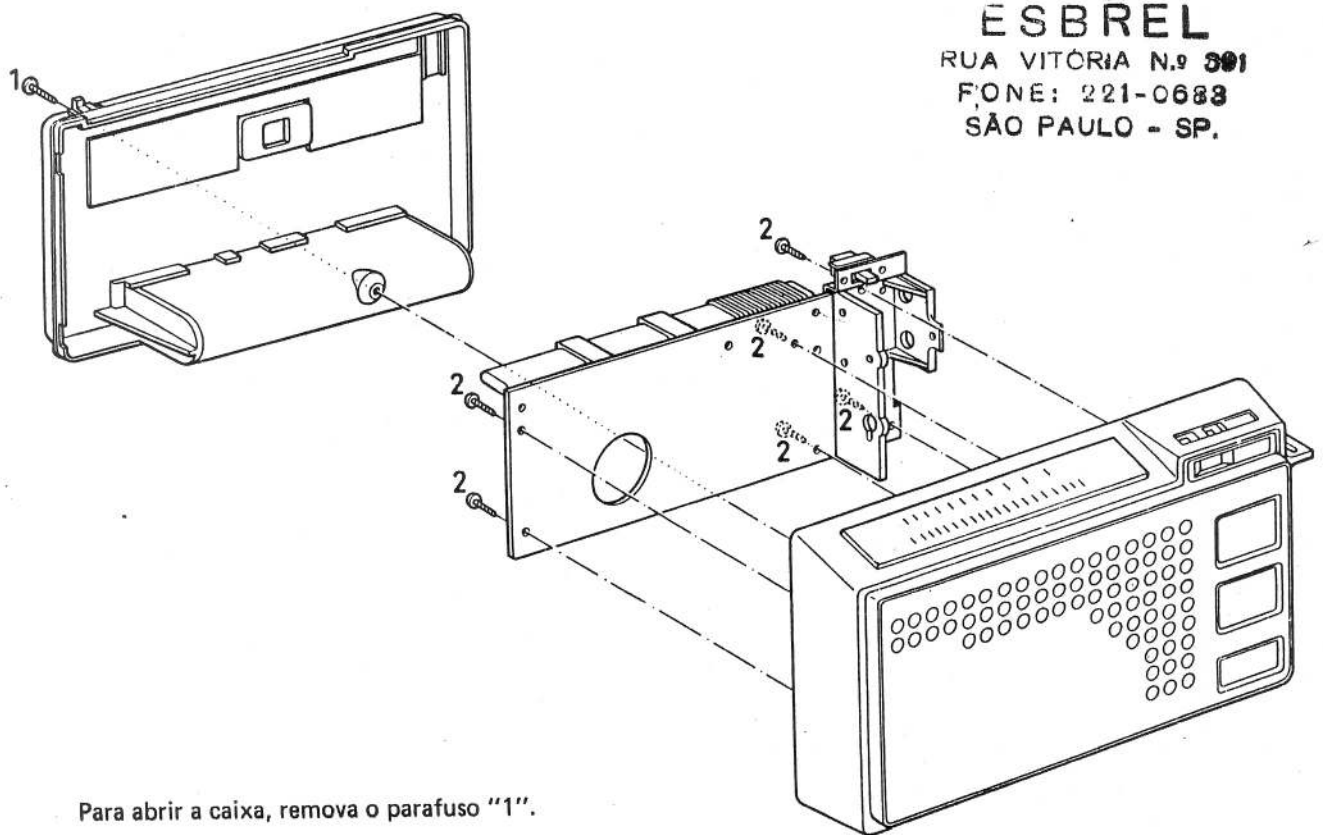

ESBREL
RUA VITÓRIA N.º 301
FONE: 221-0688
SÃO PAULO - SP.

Para abrir a caixa, remova o parafuso "1".
Para soltar o painel impresso, remova os parafusos "2".

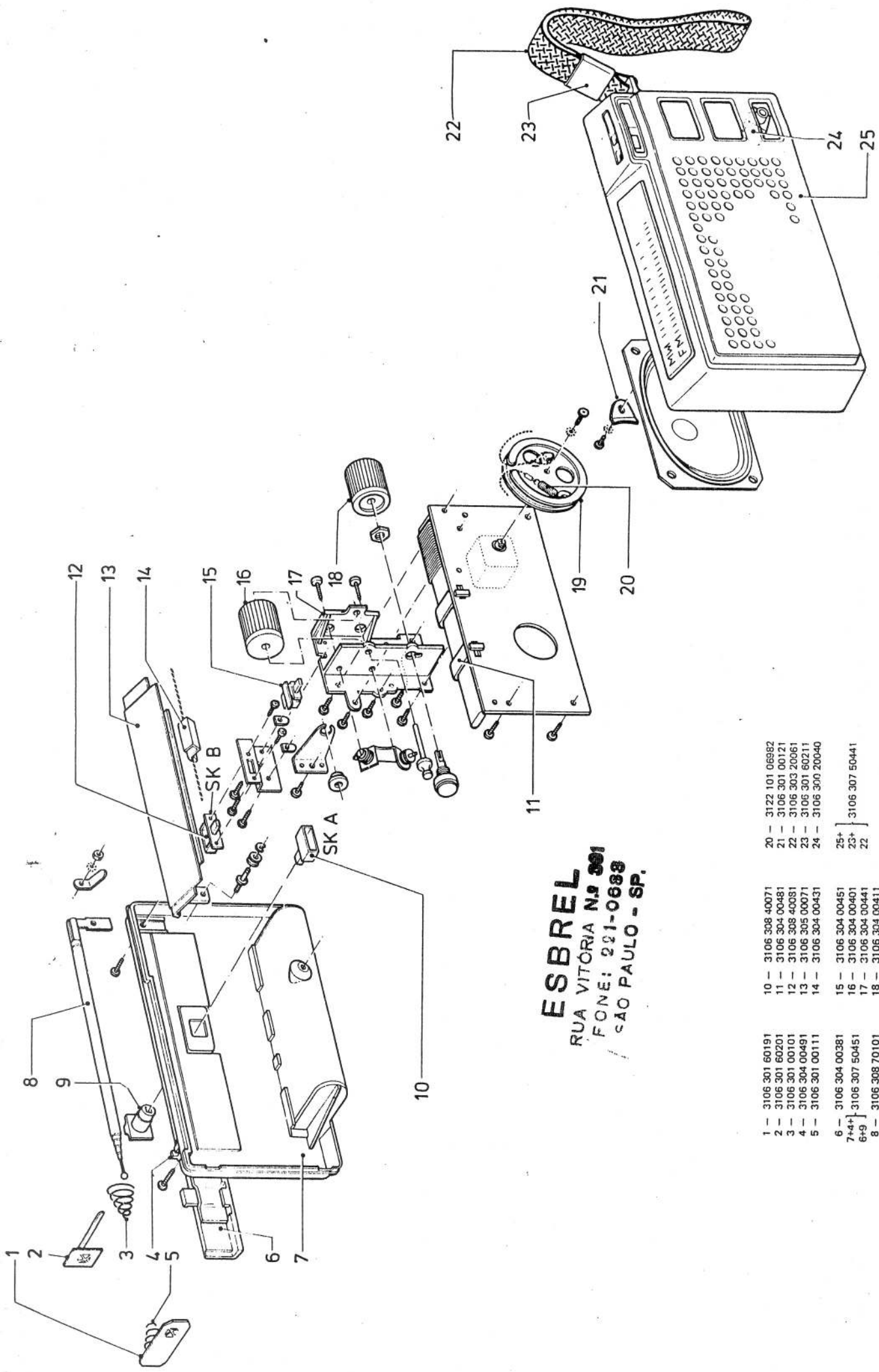

ESBREL
 RUA VITÓRIA N.º 301
 FONE: 221-0688
 SÃO PAULO - SP.

- | | | |
|--------------------|---------------------|---------------------|
| 1 - 3106 301 60191 | 10 - 3106 308 40071 | 20 - 3122 101 06982 |
| 2 - 3106 301 60201 | 11 - 3106 304 00481 | 21 - 3106 301 00121 |
| 3 - 3106 301 00101 | 12 - 3106 308 40081 | 22 - 3106 303 20061 |
| 4 - 3106 304 00491 | 13 - 3106 305 00071 | 23 - 3106 301 60211 |
| 5 - 3106 301 00111 | 14 - 3106 304 00431 | 24 - 3106 300 20040 |
| 6 - 3106 304 00381 | 15 - 3106 304 00451 | 25+ } |
| 7+4+ } | 16 - 3106 304 00401 | 23+ } |
| 6+9 } | 17 - 3106 304 00441 | 22 } |
| 8 - 3106 308 70101 | 18 - 3106 304 00411 | |
| 9 - 3106 304 00461 | 19 - 3106 304 00421 | |

TS - S - D : 430-431-432-402-413-414-434 - 401-433-435 - 440-403-415-441-416-436 - 404-420-405 - 437 - 419-417-443-439-409-438-488bb-408-410-407-406
 C : 457 - 480 - 451-459-455-461 - 462-450 - 502-485-484-467-491 - 478 - 468-477-495-469 - 503-472 - 475 - 470 - 473-487 - 489 - 490
 C : 456-458 - 453-498-454-452-483-500 - 463 - 466-464 - 496 - 465-479 - 480-492 - 476 - 494-471-493-481 - 482 - 474 - 489-497
 R : 513 - 512 - 519 - 536 - 518 - 516 - 523 - 522 - 526 - 525 - 533 - 534-531-535-546-543-538-544 - 540
 R : 514 - 511 - 510 - 515 - 520 - 532 - 521 - 527 - 524 - 547 - 542-529-539-548-528-530-541-545

446

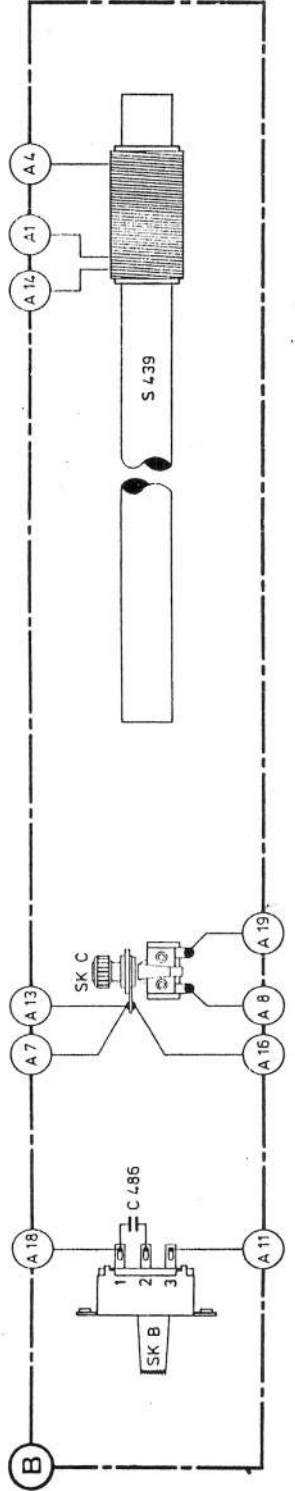
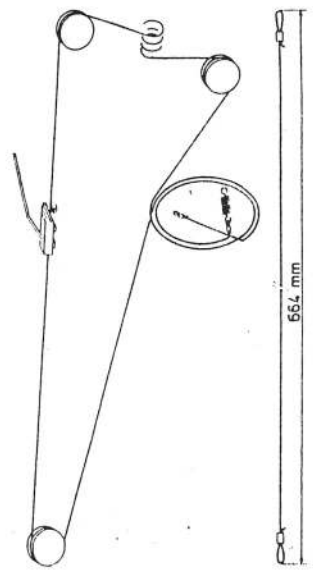
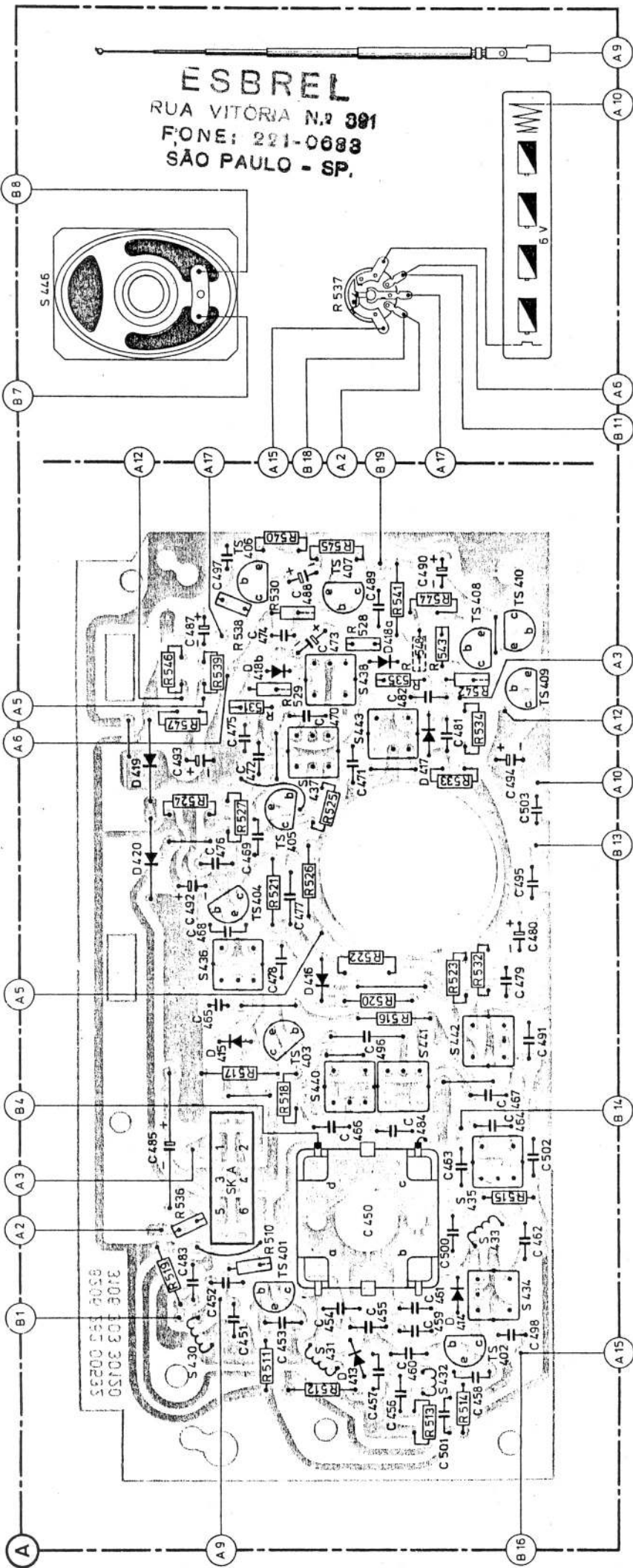

TS - S-D :	406-407-410-408-48ab-438-409 - 443-417-419-437 - 405-420-404 - 436-416-441-415-403-440 - 435-433-401-434 - 414-413-402-432-431-430
C :	490-489-487-473 - 470-475-503 - 469-495-477-468 - 478 - 491-467-484-485-502 - 450-462-461-455-459-451-460-457 - 501
C :	497-488 - 474 - 482-481-493-471-494 - 476 - 492-480 - 479-465-496 - 494-466-463 - 500-483-452-454-498-453-458-456
R :	540-544-538-543-546-535-531-534 - 533 - 525 - 526 - 522-523-516 - 518 - 496 - 536 - 519 - 512 - 513
R :	545-541-530-528-548-539-529-542-547 - 524 - 527 - 521 - 532-520-517 - 515 - 510 - 511 - 514

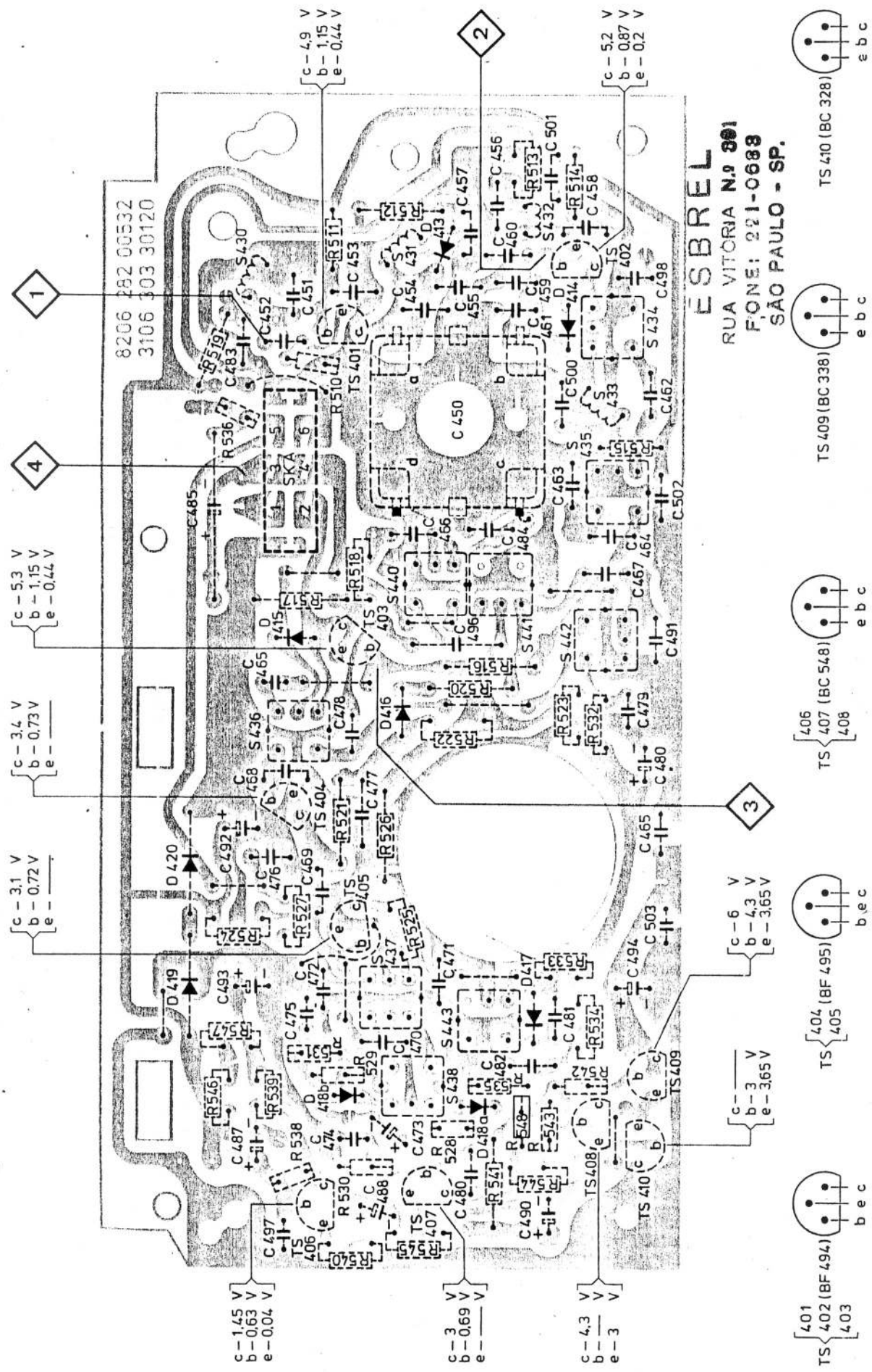
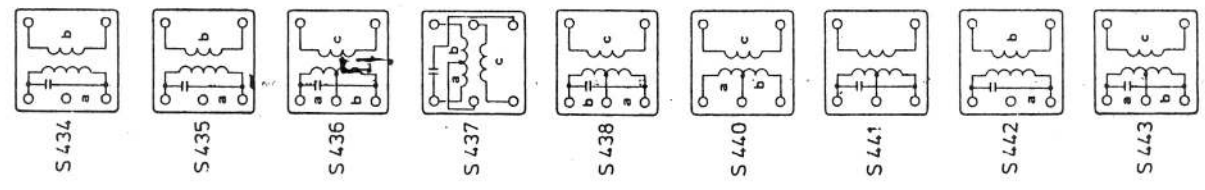

ESBREL
 RUA VITÓRIA N.º 301
 FONE: 221-0688
 SÃO PAULO - SP.

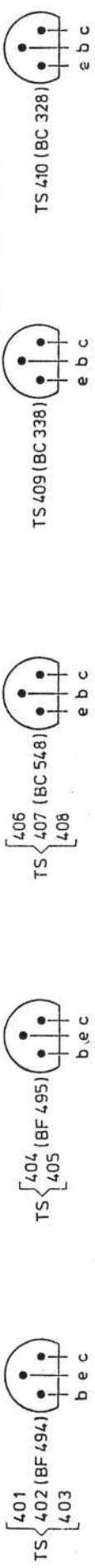

06 RL-150 Philips

TS-50	430	401-413	431	432-439	402	414	415-441	436	442	404-416	443-447-405	437-438-419-420-406	418-0b	407	408-409-410	446
C	451-452	450e-450g-455-458-456-459	461-483	503	450h-464	491	478-480	469	471	482-472-486	497	496-473	474-493	495	490	
C	453	454	502-457-450a-450c	460	4501-450b	462	483	450d-484	467	468-479	477-481	470	476-501-487-485-492	488	489-475-494	498-503
R	510	512	514	515	517	518	516	519	520	522-524-535	525	537-538	546-540-529-544-531-542-545	539	528-548-530-547-543-541	

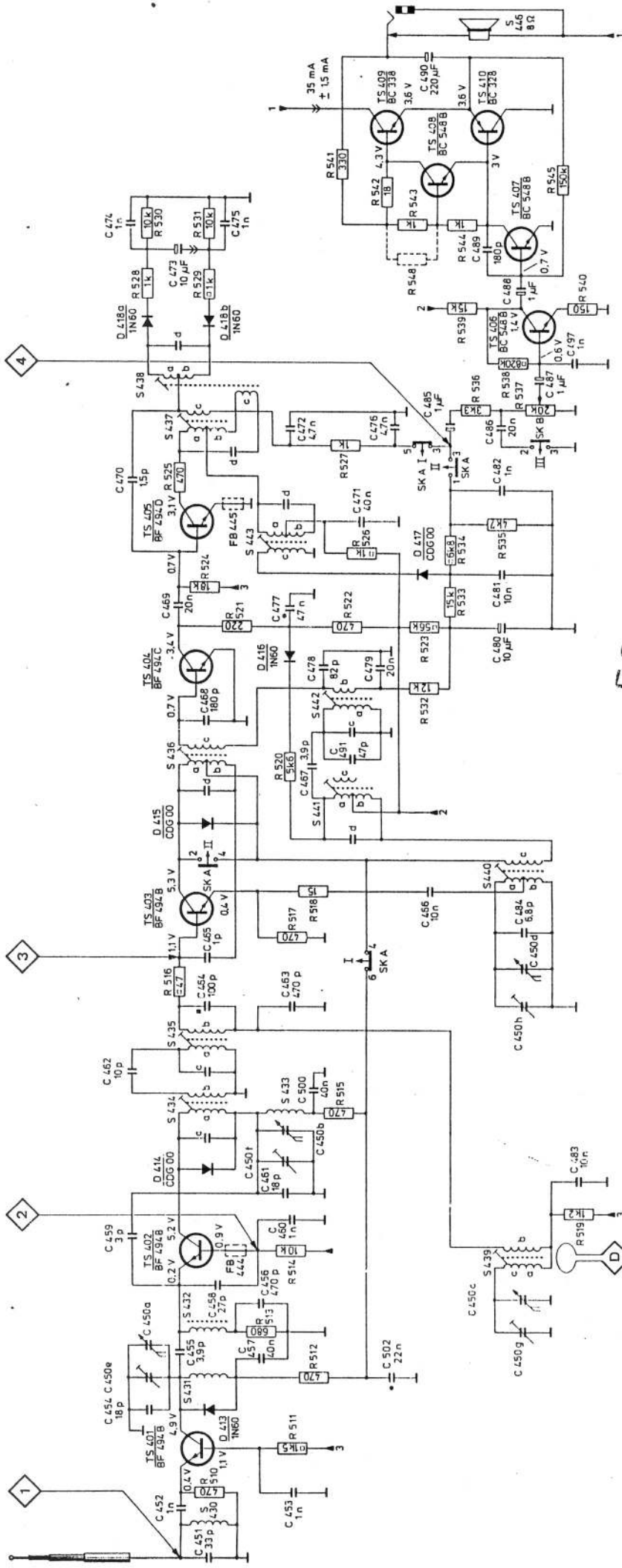

ESBREL
 RUA VITÓRIA N.º 281
 FONE: 241-0683
 SÃO PAULO - SP.

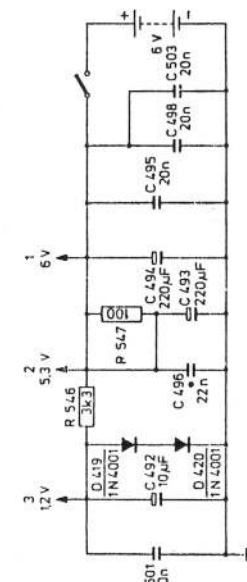

- RESISTOR CARVÃO 0125 W
- CAPACITOR STYROFLEX
- CAPACITOR POLIESTER
- VOLTIMETRO ELETRÔNICO
- SK A 05 03 01
- SK B 01 02 03
- I - FM
- II - AM
- III - ONALIDADE